

## ZF 2050 A

10° Down angle, direct or remote mount marine transmission.

### Maximum Input\*\*

Duty	kW	hp	RPM
Pleasure	1231	1650	2600
Light	1073	1438	2600
Medium	791	1061	2600
Continuous	559	750	2600

\*\* Must not be exceeded

## Description

- 3 shaft, reverse reduction transmission with hydraulic clutch mounted on the input shaft and another one mounted on the reverse shaft. Input drive on opposite side to output drive.
- Non-reversing NR version also available .
- Fully works tested, reliable and simple to install .
- Suitable for high performance applications in luxury motoryachts, sport fishers, express cruisers etc .
- Design, manufacture and quality control standards comply with ISO 9001 .
- Compatible with all types of engines and propulsion systems, including waterjets and surface- piercing propellers, as applicable .

## Features

- Lightweight and robust aluminum alloy casing (sea water resistant) .
- Case hardened and precisely ground gear teeth for long life and smooth running .
- Output shaft thrust bearing designed to take maximum propeller thrust astern and ahead .
- Compact, space-saving design, complete with oil cooler, pump and full flow filter .
- Smooth and reliable hydraulic shifting with electric actuation .
- Suitable for twin engine installations (same ratio and torque capacity in ahead or astern mode) .
- Emergency "get home" capability .
- "SUPERSHIFT" clutch control .

## Options

- Engine-matched torsional coupling .
- Mounting brackets .
- Propeller shaft flange and coupling bolt sets .
- SAE 1 or SAE 0 bell housings .
- Live PTO's: Pump shaft driven, input shaft driven, TOP PTO .
- Mechanical actuation with lever for attachment of push-pull cable .
- Monitoring kit .
- Trailing pump .
- Input flange for 'A' type - option .
- Classification by all major Classification Societies on request .
- Supershift (with Autotroll and Easidock) .

# ZF 2050 A

## Ratings

### Pleasure Duty

RATIOS	MAX. TORQUE		POWER/RPM		MAXIMUM RATED POWER						MAX. RPM
	Nm	ftlb	kW	hp	2100 rpm		2300 rpm		2450 rpm		
<span style="color: red;">■</span> 1.267*, 1.512*, 1.763, 2.029, 2.250*, 2.467	4802	3542	0.5028	0.6743	1056	1416	1157	1551	1232	1652	2600

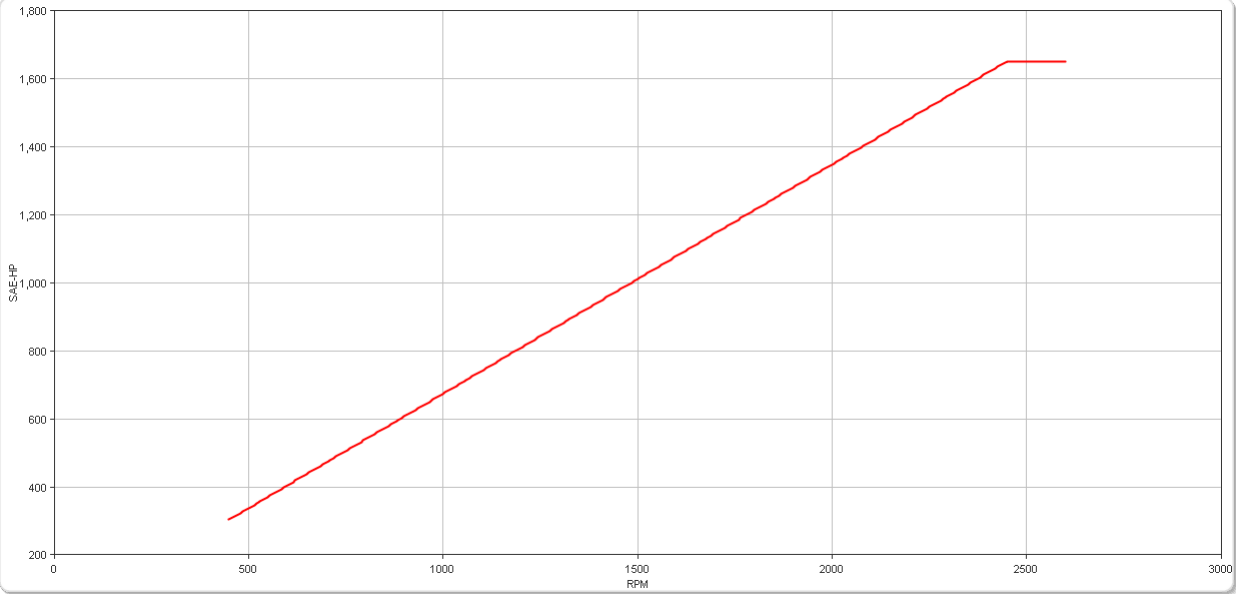
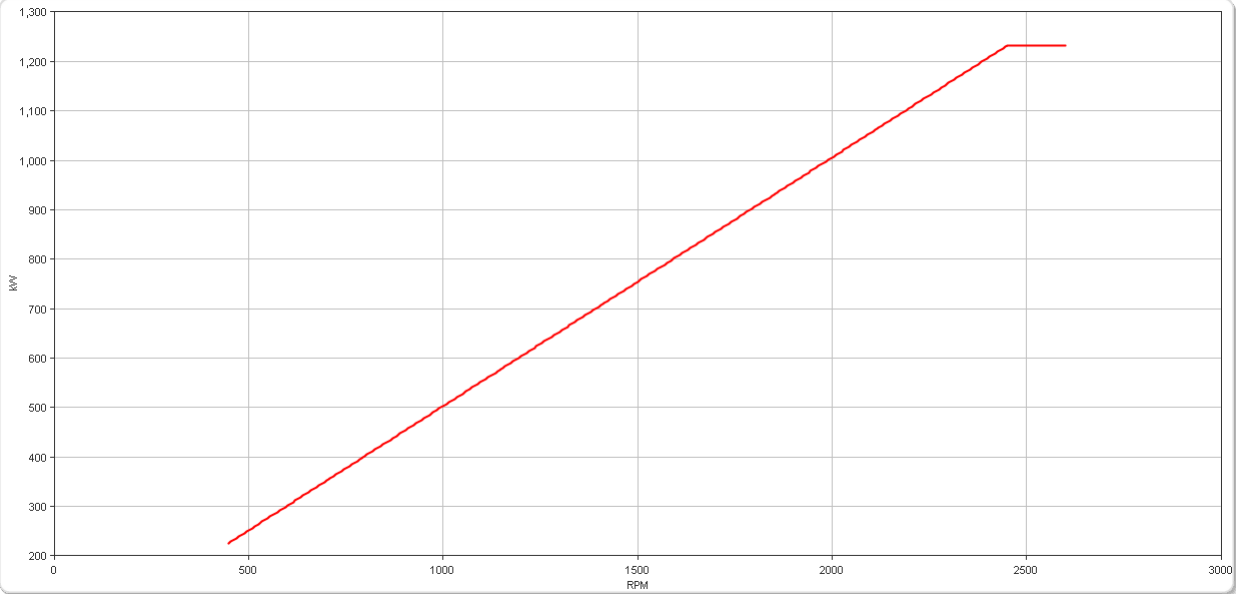

# ZF 2050 A

## Ratings

### Light Duty

RATIOS	MAX. TORQUE		POWER/RPM		MAXIMUM RATED POWER						MAX. RPM
	Nm	ftlb	kW	hp	2100 rpm		2300 rpm		2450 rpm		
<span style="color: red;">■</span> 1.267*, 1.512*, 1.763, 2.029, 2.250*, 2.467	4185	3087	0.4382	0.5877	920	1234	1008	1352	1074	1440	2600

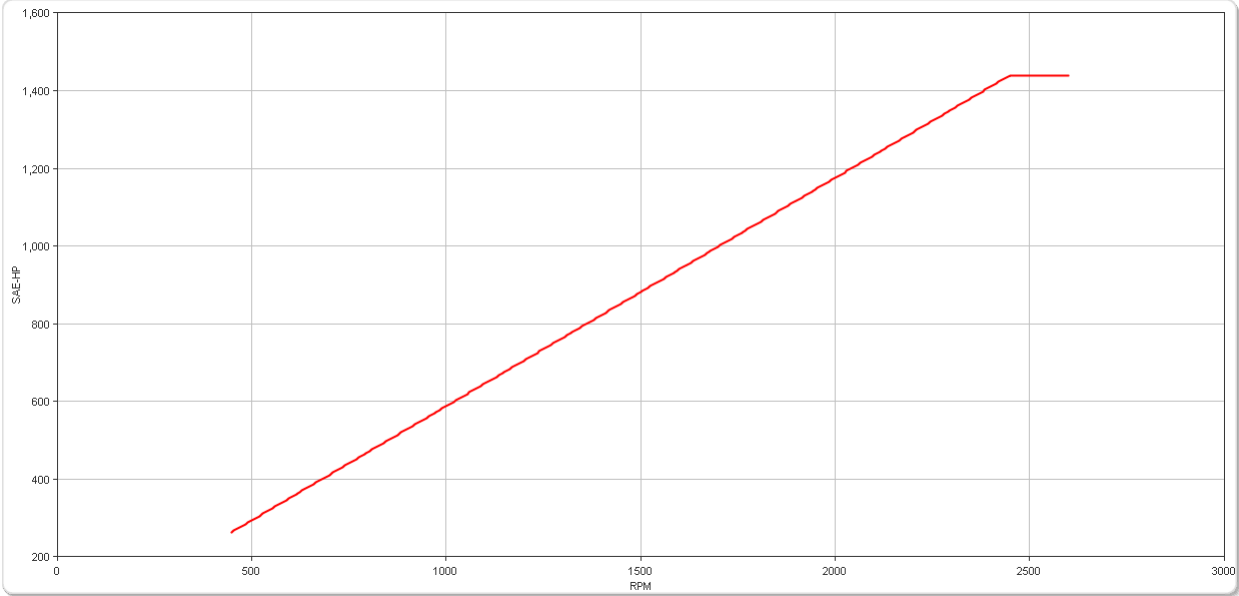
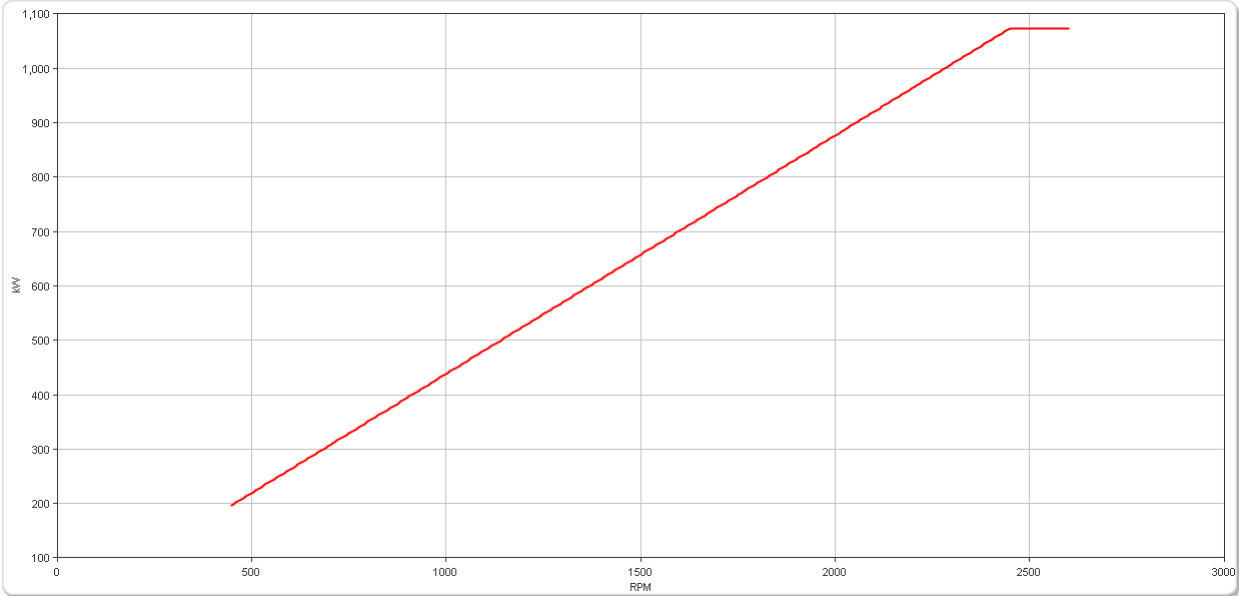

# ZF 2050 A

## Ratings

### Medium Duty

RATIOS	MAX. TORQUE		POWER/RPM		MAXIMUM RATED POWER						MAX. RPM
	Nm	ftlb	kW	hp	1800 rpm		1900 rpm		2100 rpm		
<span style="color: red;">■</span> 1.267*, 1.512*, 1.763, 2.029, 2.250*, 2.467	3601	2656	0.3771	0.5057	679	910	716	961	792	1062	2600

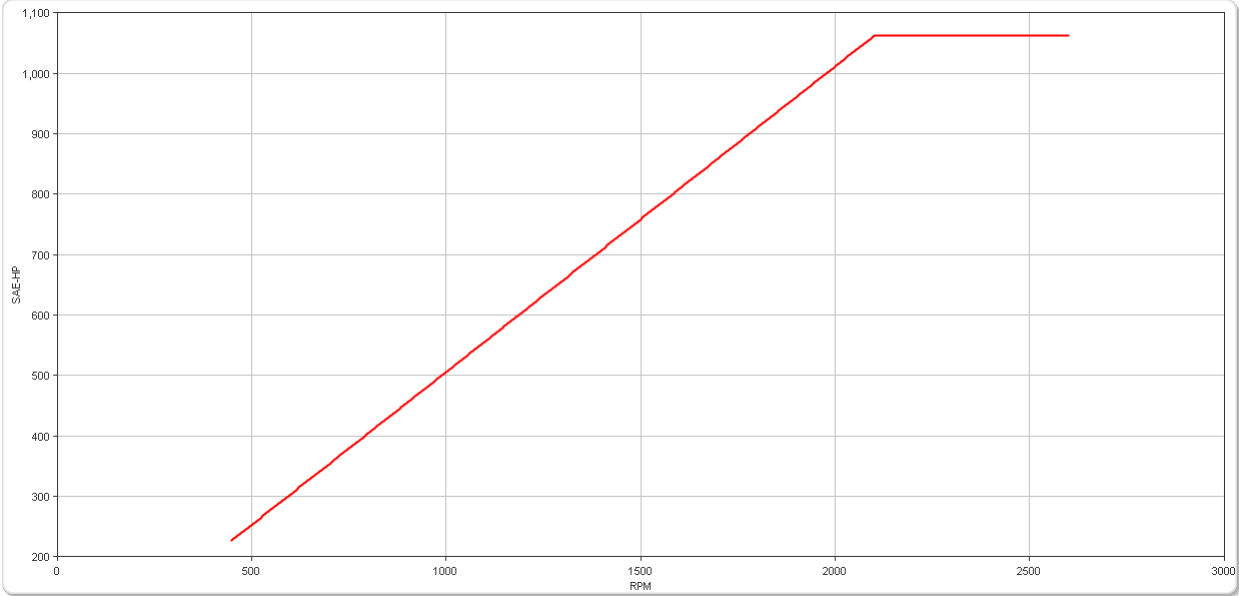
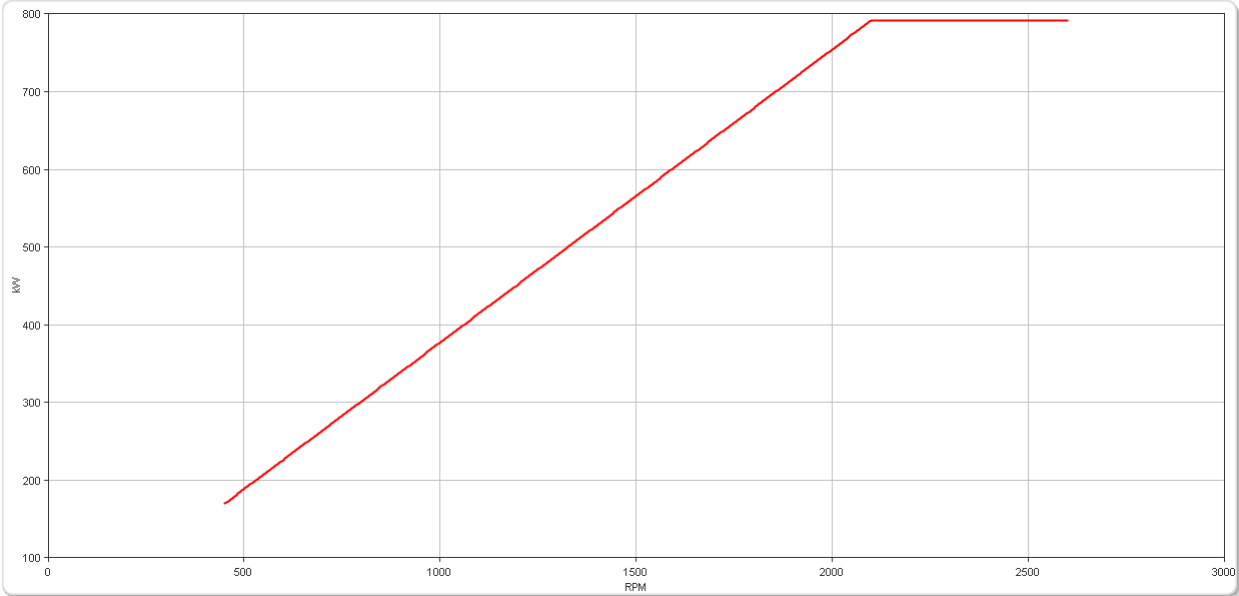

# ZF 2050 A

## Ratings

### Continuous Duty

RATIOS	MAX. TORQUE		POWER/RPM		MAXIMUM RATED POWER						MAX. RPM
	Nm	ftlb	kW	hp	1200 rpm		1600 rpm		1800 rpm		
<span style="color: red;">■</span> 1.267*, 1.512*, 1.763, 2.029, 2.250*, 2.467	2971	2191	0.3111	0.4172	373	501	498	668	560	751	2600

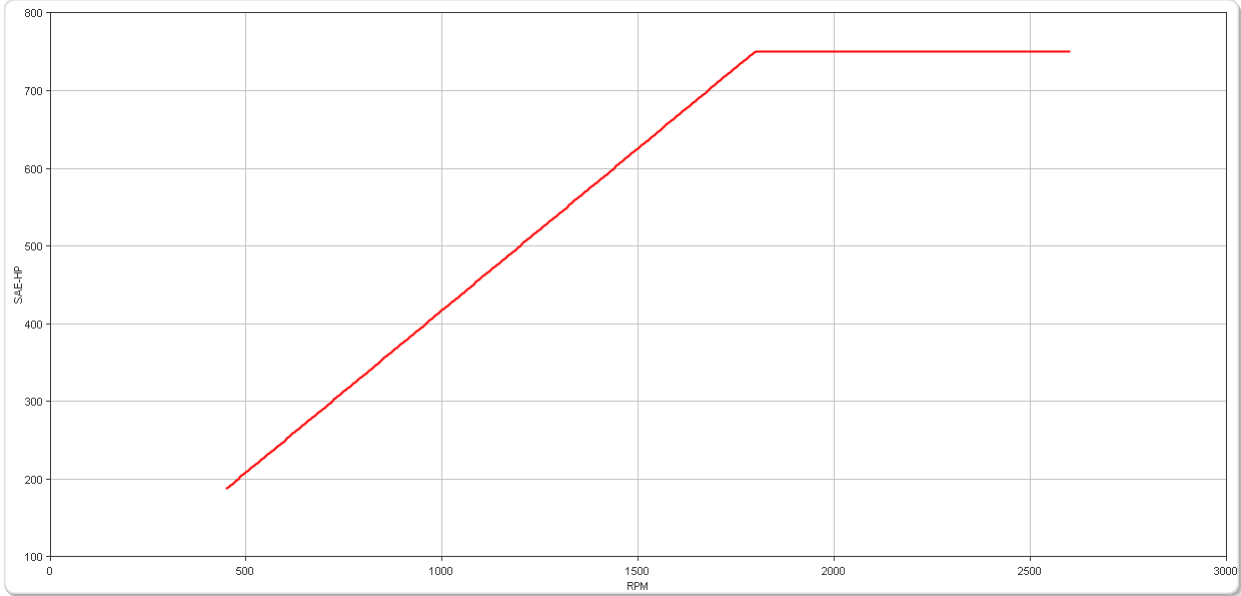
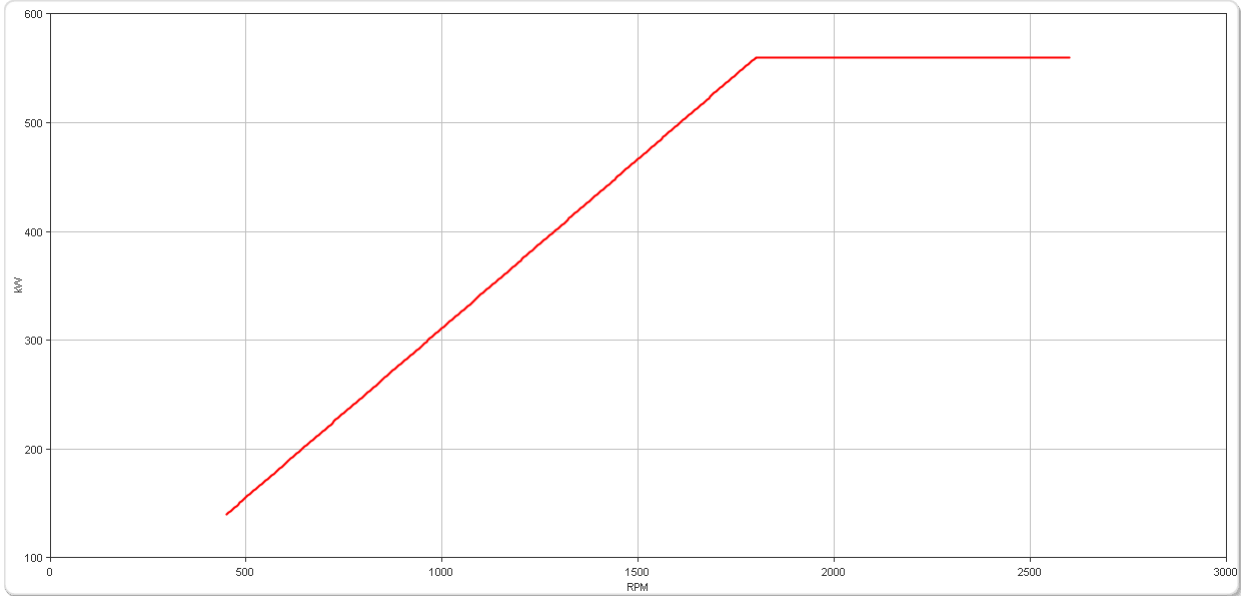

# ZF 2050 A

## Dimensions

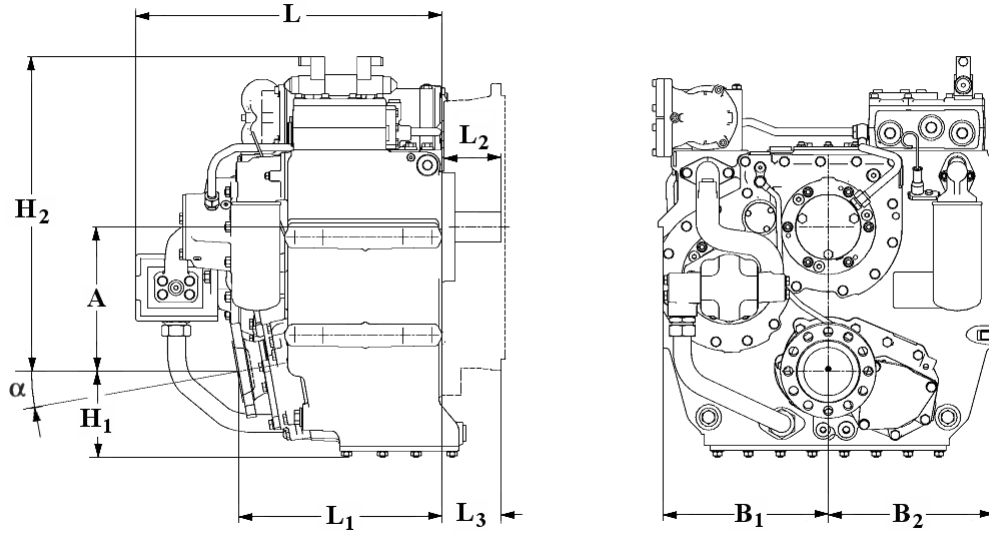

mm (inches)										
Angle	A	B <sub>1</sub>	B <sub>2</sub>	H <sub>1</sub>	H <sub>2</sub>	L	L <sub>1</sub>	L <sub>2</sub>	L <sub>3</sub>	Bell Hsg.
10.0	280 (11.0)	320 (12.6)	320 (12.6)	167 (6.57)	575 (22.6)	595 (23.4)	394 (15.5)	115 (4.53)	115 (4.53)	1
Weight kg (lb)						Oil Capacity Litre (US qt)				
350 (770)						21.0 (22.3)				

### SAE Bell Housing Dimensions

SAE No.	A		B		C		Bolt Holes		
	mm	in	mm	in	mm	in	No.	Diameter	
	mm	in	mm	in	mm	in		mm	in
0	647.7	25.5	679.45	26.75	711.2	28.0	16	13.49	17/32
1	511.18	20.125	530.23	20.875	552.45	21.75	12	11.91	15/32

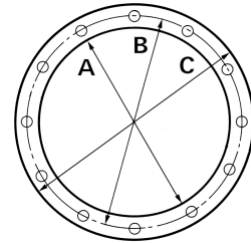

### Output Coupling Dimensions

A		B		C		D		Bolt Holes		
mm	in	mm	in	mm	in	mm	in	No.	Diameter (E)	
mm	in	mm	in	mm	in	mm	in		mm	in
185	7.28	156	6.12	120	4.72	18.0	0.71	12	18.2	0.72

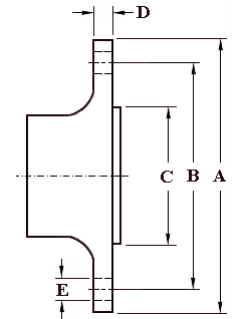

## Duty Definitions

<b>PLEASURE DUTY DEFINITION</b>	Highly intermittent operation with very large variations in engine speed and power
Average engine operating hours limit:	500 hours/year 300 hours/year for mechanical gearboxes
Typical hull forms:	Planing.
Typical applications:	Private, non-commercial, non-charter sport/leisure activities.
<b>LIGHT DUTY DEFINITION</b>	Intermittent operation with large variations in engine speed and power
Average engine operating hours limit:	2500 hours/year (for hydraulic gearboxes smaller than the ZF 650 series, 2000 hours/year).
Typical hull forms:	Planing and semi-displacement.
Typical applications:	Private and charter, sport/leisure activities, naval and police activities.
<b>MEDIUM DUTY DEFINITION</b>	Intermittent operation with some variations in engine speed and power
Average engine operating hours limit:	4000 hours/year. 3500 hours/year for gearboxes smaller than ZF 2000 series and workboat ZF W2700 series.
Typical hull forms:	Semi-displacement and displacement
Typical applications:	Charter and commercial craft (example: crew boats and fast ferries), and naval and police activities.
<b>CONTINUOUS DUTY DEFINITION</b>	Continuous operation with little or no variations in engine speed and power
Average engine operating hours limit:	Unlimited
Typical hull forms:	Displacement.
Typical applications:	Heavy duty commercial vessels, tugs, fishing boats.

## Duty Ratings

Ratings apply to marine diesel engines at the indicated speeds. At other engine speeds, the respective power capacity (kW) of the transmission can be obtained by multiplying the Power/Speed ratio by the speed.

Approximate conversion factors:

1 kW = 1.36 metric hp

1 kW = 1.34 U.S. hp (SAE)

1 U.S. hp = 1.014 metric hp

1 Nm = 0.74 lb.ft.

Ratings apply to right hand turning engines, i.e. engines having counterclockwise rotating flywheels when viewing the flywheel end of the engine. These ratings allow full power through forward and reverse gear trains, unless otherwise stated.

Contact your nearest ZF Sales and Service office for ratings applicable to gas turbines, gasoline (petrol) engines, as well as left hand turning engines, and marine transmissions for large horsepower capacity engines.

Ratings apply to marine transmissions currently in production or in development and are subject to change without prior notice.

**NOTE:** THE MAXIMUM RATED INPUT POWER MUST NOT BE EXCEEDED (SEE RESPECTIVE RATINGS IN THE TECHNICAL DATA SHEETS)

## Safe Operating Notice

The safe operation of ZF products depends upon adherence to technical data presented in our brochures. Safe operation also depends upon proper installation, operation and routine maintenance and inspection under prevailing conditions and recommendations set forth by ZF. Damage to transmission caused by repeated or continuous emergency manoeuvres or abnormal operation is not covered under warranty. It is the responsibility of users and not ZF to provide and install guards and safety devices, which may be required by recognized safety standards of the respective country (e.g. for U.S.A. the Occupational Safety Act of 1970 and its subsequent provisions).

## Monitoring Notice

The safe operation of ZF products depends upon adherence to ZF monitoring recommendations presented in our operating manuals, etc. It is the responsibility of users and not ZF to provide and install monitoring devices and safety interlock systems as may be deemed prudent by ZF. Consult ZF for details and recommendations.

## Torsional Responsibility and Torsional Couplings

The responsibility for ensuring torsional compatibility rests with the assembler of the drive and driven equipment. ZF can accept no liability for gearbox noise caused by vibrations or for damage to the gearbox, the flexible coupling or to other parts of the drive unit caused by this kind of vibration. Contact ZF for further information and assistance. ZF recommends the use of a torsional limit stop for single engine powered boats, wherein loss of propulsion power can result in loss of control. It is the buyer's responsibility to specify this option, which can result in additional cost and a possible increase in installation length.

ZF can accept no liability for personal injury, loss of life, or damage or loss of property due to the failure of the buyer to specify a torsional limit stop. ZF selects torsional couplings on the basis of nominal input torque ratings and commonly accepted rated engine governed speeds. Consult ZF for details concerning speed limits of standard offering torsional couplings, which can be less than the transmission limit. Special torsional couplings may be required for Survey Society Ice Classification requirements.

